

# MANIACCESS **150 AETJ L**



## Self-propelled bi-energy articulating boom

- Environment friendly
- Versatile :
  - Indoor : electric
  - Outdoor : diesel
- Low noise diesel engine

# 150 AETJ L

 **Working height** .....15.40 m  
**Platform height**.....13.40 m  
**Outreach**.....7.81 m  
**Up and over** .....7.27 m

 **Basket rotation** .....140°  
**Turret rotation** .....355°

 **Platform capacity** .....230 kg (2 people)  
**Basket size** .....1.20\*0.92 m

 **① Width** .....1.90 m  
**② Length**.....6.10 m  
**③ Stowed length** .....4.53 m  
**④ Height** .....2.10 m  
**Turning radius :**  
**⑤ Inside**.....1.97 m  
**⑥ Outside**.....4.27 m  
**⑦ Ground clearance**.....17.5 cm

 **Drive speed** .....6 km/h  
**Working speed**.....0.6 km/h

 **Gradeability** .....25%  
**Max. slope accepted** .....5° or 9°

 **Weight** .....6435 kg

 **Tyres**.....Foam filled 12'

 **Traction battery**.....2\*24 V/300 Ah  
**Integrated charger** .....48 V/45 Ah

 **Engine** .....Lombardini FOCS 702 water cooled  
**Power**.....9.2 kW  
**Generator**...48 V/5.7 kW - 100 Amp/2500 rpm

## Standard equipment:

- Protected control basket pane
- Lifting brackets
- Hour meter
- Horn
- 220 V predisposal
- Battery charge indicator
- Safety manual pump
- Basket with mesh floor
- Integrated charger
- BusCAN technology
- Diagnostic help integrated

## Options :

- Air predisposal
- Water predisposal
- Electric plug in the platform with circuit breaker (230 V)
- Working lights
- Flashing light
- Drive alarm
- All motion alarm
- Central filling

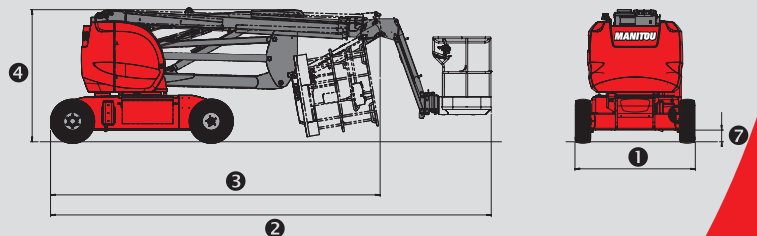
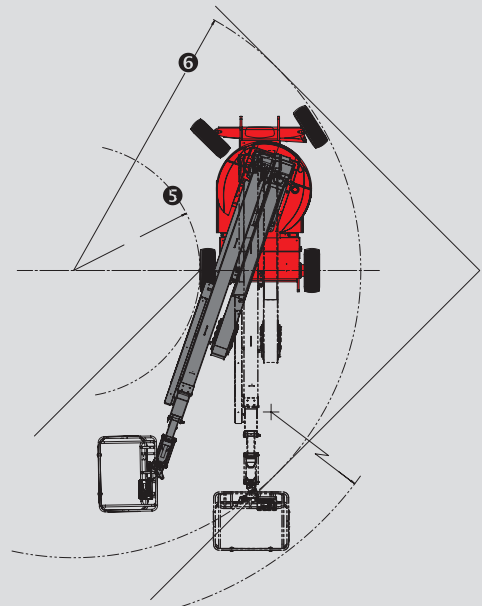
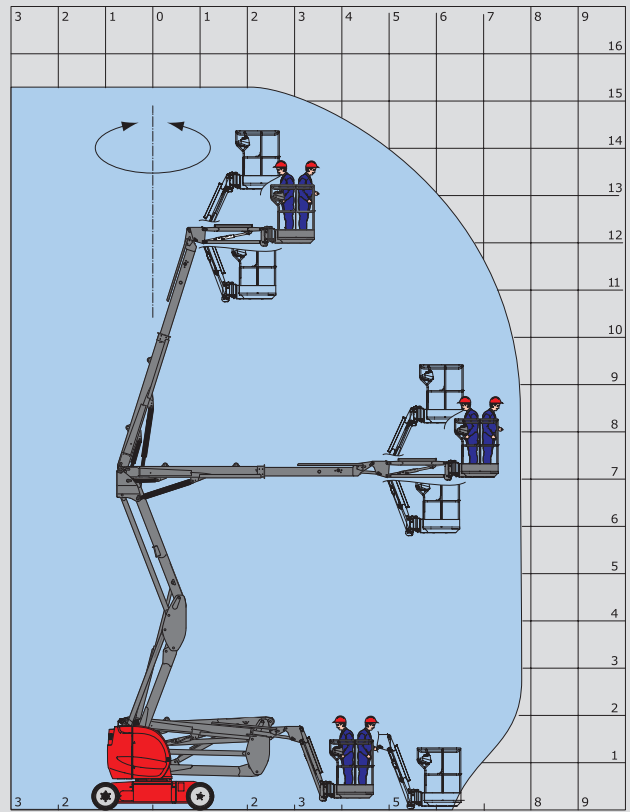

The specifications given are not binding to the manufacturer and can be modified without prior notification.  
 The equipment shown in this leaflet may be standard, optional or unavailable depending on the version. For further details, please contact your MANITOU dealer.  
 Complies with the machine directive (EN 280) and standards in the countries where the machine is delivered.